



OWNER'S MANUAL

PBM8.250/8.500 MKII

POWERED BOX MIXER



www.altoproaudio.com
Version 2.0 NOV. 2007

English



TO REDUCE THE RISK OF ELECTRIC SHOCK PLEASE DO NOT REMOVE THE COVER OR THE BACK PANEL OF THIS EQUIPMENT. THERE ARE NO PARTS NEEDED BY USER INSIDE THE EQUIPMENT. FOR SERVICE, PLEASE CONTACT QUALIFIED SERVICE CENTERS.

This symbol, wherever used, alerts you to the presence of un-insulated and dangerous voltages within the product enclosure. These are voltages that may be sufficient to constitute the risk of electric shock or death.

This symbol, wherever used, alerts you to important operating and maintenance instructions. Please read.

- ⊕ Protective Ground Terminal
- ~ AC mains (Alternating Current)
- ⚡ Hazardous Live Terminal

ON: Denotes the product is turned on.
OFF: Denotes the product is turned off.

CAUTION

Describes precautions that should be observed to prevent damage to the product.

1. Read this Manual carefully before operation.
2. Keep this Manual in a safe place.
3. Be aware of all warnings reported with this symbol.
4. Keep this Equipment away from water and moisture.
5. Clean it only with dry cloth. Do not use solvent or other chemicals.
6. Do not damp or cover any cooling opening. Install the equipment only in accordance with the Manufacturer's instructions.
7. Power Cords are designed for your safety. Do not remove Ground connections! If the plug does not fit your AC outlet, seek advice from a qualified electrician. Protect the power cord and plug from any physical stress to avoid risk of electric shock. Do not place heavy objects on the power cord. This could cause electric shock or fire.
8. Unplug this equipment when unused for long periods of time or during a storm.
9. Refer all service to qualified service personnel only. Do not perform any servicing other than those instructions contained within the User's Manual.
10. To prevent fire and damage to the product, use only the recommended fuse type as indicated in this manual. Do not short-circuit the fuse holder. Before replacing the fuse, make sure that the product is OFF and disconnected from the AC outlet.

WARNING

To reduce the risk of electric shock and fire, do not expose this equipment to moisture or rain.



Dispose of this product should not be placed in municipal waste and should be separate collection.

11. Move this Equipment only with a cart, stand, tripod, or bracket, specified by the manufacturer, or sold with the Equipment. When a cart is used, use caution when moving the cart / equipment combination to avoid possible injury from tip-over.



12. Permanent hearing loss may be caused by exposure to extremely high noise levels. The US. Government's Occupational Safety and Health Administration (OSHA) has specified the permissible exposure to noise level. These are shown in the following chart:

HOURS X DAY SPL EXAMPLE

8	90 Small gig
6	92 train
4	95 Subway train
3	97 High level desktop monitors
2	100 Classic music concert
1,5	102
1	105
0,5	110
0,25 or less	115 Rock concert

According to OSHA, an exposure to high SPL in excess of these limits may result in the loss of heat. To avoid the potential damage of heat, it is recommended that Personnel exposed to equipment capable of generating high SPL use hearing protection while such equipment is under operation.

The apparatus shall be connected to a mains socket outlet with a protective earthing connection.

The mains plug or an appliance coupler is used as the disconnect device, the disconnect device shall remain readily operable.

IN THIS MANUAL:

1. INTRODUCTION.....	1
2. FEATURES.....	1
3. QUICK START.....	4
4. CONTROL ELEMENTS.....	5
5. INSTALLATION & CONNECTION.....	12
6. PRESET LIST.....	16
7. BLOCK DIAGRAM.....	17
8. TECHNICAL SPECIFICATIONS.....	18
9. WARRANTY.....	20

1. INTRODUCTION

Thank you for purchasing the ▲LTO PBM8 8 channel powered mixer with 24-bit digital multi-effect built-in. It is just one of the many ▲LTO products that a talented, multinational Team of Audio Engineers and Musicians have developed with their great passion for music. Your PBM8 is a remarkable compact powered mixer that doesn't find many equals in the market today. With 6 microphone and 2 stereo MIC/Line-level inputs for serious live performances, your PBM8 also includes a 24 Bit digital multi-effect with 16 Factory Presets and 16 variations for every preset, for a total of 256 different digital effects. There is a three bands EQ on all input channels and separate Master EQ for Main Mix and Monitor Outputs. Use it for small Gigs, for Church applications and for Conference.

Enjoy your PBM8 and make sure to read this Manual carefully before operation!

2. FEATURES

- ▲ 6 MIC/Line input channels with gold plated XLR and balanced Line inputs
- ▲ 2 Stereo input channels with balanced TRS jacks
- ▲ Ultra-low noise discrete MIC preamps with +48V phantom power
- ▲ Extremely high headroom offering more dynamic range
- ▲ Each input channel with -20 dB PAD, PAN and level control
- ▲ 3-band equalizer on input channels
- ▲ 2 AUX sends for built-in or external effects, on-stage monitor mix, or headphone mixing
- ▲ Built-in feedback terminator
- ▲ 9-band graphic EQ for MAIN/MONITOR
- ▲ 256 position multi-effect
- ▲ 2-track recording IN/OUT (PHONO)
- ▲ Headphone output
- ▲ Stereo Line-level output
- ▲ 2x250 watt RMS amplifiers (For PBM8.250 MKII)
- ▲ 2x500 watt RMS amplifiers (For PBM8.500 MKII)
- ▲ Output connector: 6.3 ϕ jack + 4 way-speakon

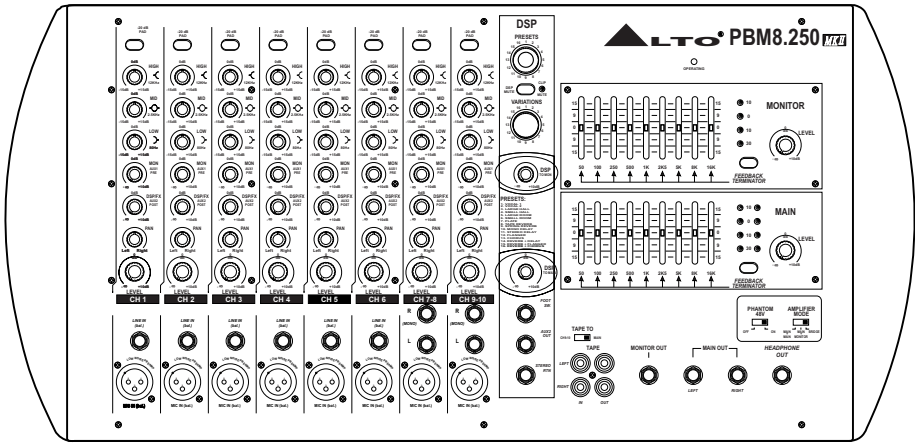

PMB8.250 MKII

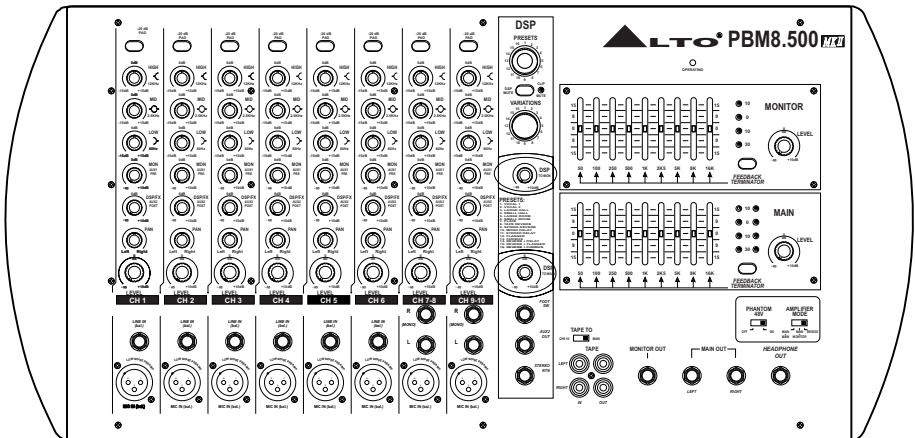

PMB8.500 MKII

3. QUICK START

This is the fastest way to get something out from your PBMB, if you have a keyboard and a microphone.

- a. Plug the microphone into Channel 1 MIC IN.
- b. Turn down AUX and LEVEL controls on the input channel.
- c. Turn down MONITOR and MAIN master controls.
- d. Put the EQ controls on center position.
- e. Connect 2 passive cabinets to the rear speaker cabinets or 2 active cabinets to the front MAIN OUT connectors.
- f. Turn on your PBMB.
- g. Sing or speak into the microphone with normal volume and adjust the channel LEVEL control of half.
- h. If you like, you can add some equalization at this stage.
- i. Turn up the MAIN LEVEL control until you reach the desired volume. The +10 LED on the Master LED meter should flash only occasionally, otherwise you will hear the distortion. If this LED is not active and you still hear distortion, please turn down a little the input LEVEL control or reduce the output level of your source instrument.
- j. Connect your stereo keyboard into channel 7/8 and repeat the sequence.

Here you are. It is your first gig with your PBMB.



SMALL CLUB

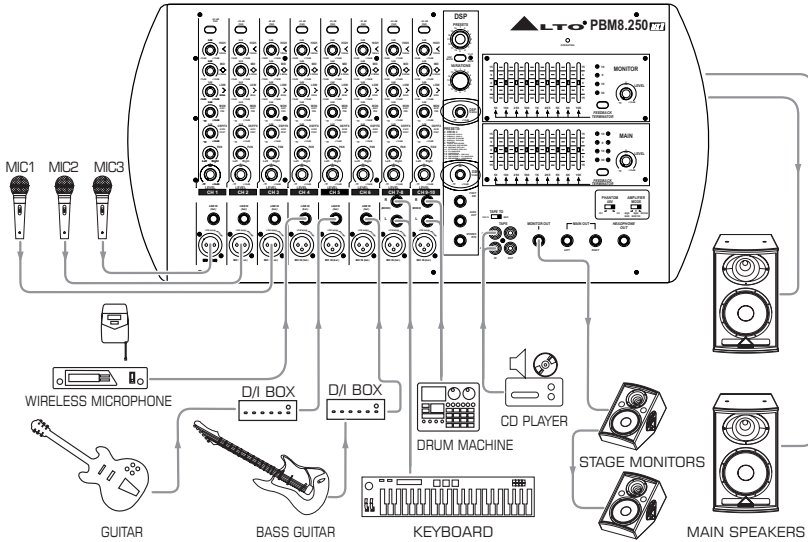

COMPUTER SET-UP DIAGRAM

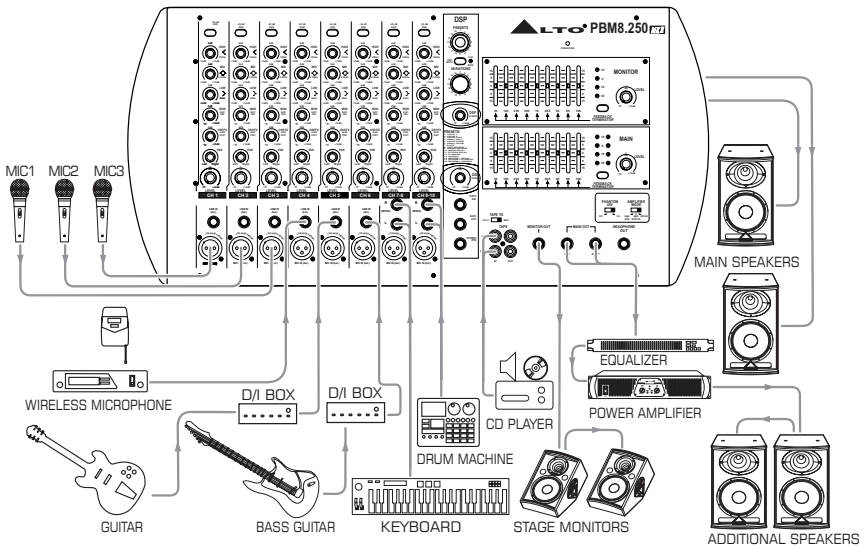



4. CONTROL ELEMENTS

1 MIC/LINE MONO INPUT (1 to 6)

Your PBM8 is equipped with 6 low-noise microphone preamplifiers with optional phantom power, 50 dB of Gain and over 90 dB of S/N ratio. You can connect almost any type of microphone. Dynamic microphones do not need phantom power. Use phantom power only with condenser microphones but make sure that the phantom power button is disengaged before connecting the microphone. Phantom power will not damage your dynamic microphones but it may damage tube or ribbon microphones. So make sure to read the microphone instructions manual before engaging phantom power. Use switch (19) to activate/deactivate phantom power. These 6 channels are also equipped with 1/4" TRS balanced/unbalanced LINE-IN plugs to connect line-level instruments such as keyboards, drum machines and effect devices.

✘NOTE: Never try to connect a line-level signal to the XLR MIC input when the phantom power is engaged, or you may seriously damage your equipment.

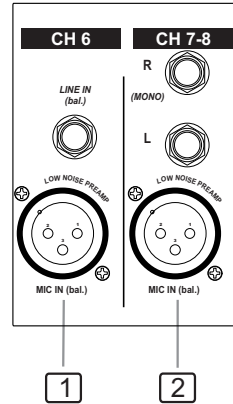

2 MIC/LINE STEREO LINE INPUTS

These are channels 7/8 and 9/10. They are organised in stereo pair and provided with XLR balanced socket and 1/4" TRS phone sockets. If you connect only the left jack, the input will operate in mono mode, that is the mono signal will appear on both input channels. You can use these inputs with a stereo keyboard, drum machine, etc.

3 LEVEL CONTROL

This control is used to adjust the overall level of respective channel. The adjustable range goes from $-\infty$ to +10 dB.

4 PAN

This is the PANORAMA control, or balance control. You can adjust the stereo image of the signal via this control. Keep this control in center position and your signal will be positioned in the middle of stage. Turn this control fully counter clockwise and the signal will be present only on the left speaker and vice-versa. Of course a large number of intermediate positions are available.

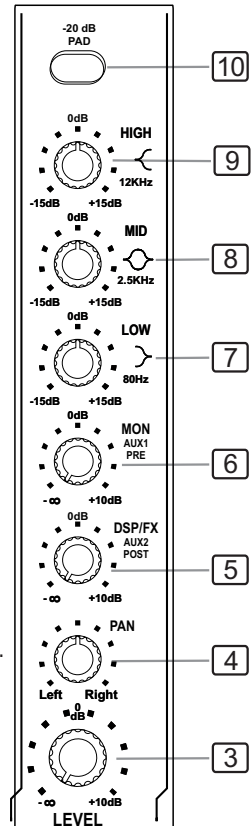



4. CONTROL ELEMENTS

5 DSP/FX

The AUX2 control is configured as POST-FADER, so the audio signal will be affected by channel LEVEL control and sent to the resident digital multi-effect. Via the AUX2 OUT jack, the AUX2 signal can be sent to an external effects device, and in such case the resident digital multi-effects will be automatically disconnected.

6 MON/AUX1

Your PBM8 has two auxiliary sends which can be used for sending signals to external or internal effects devices or for creating a monitor mix. They are used to adjust the level of respective channel signal sent to AUX bus, and the adjustable range goes from $-\infty$ to +10 dB. The AUX1 control is configured as PRE-FADER, which means that the signal is sent out before reaching the channel fader. It is used to feed stage monitors in a live situation, or for a headphone mix in recording application.

EQUALIZATION

You have three EQ controls for each mono and stereo input channel each providing +/-15dB of boost and cut. The signal will be unaffected when the controls on the center position. You may use an external equalizer to make up a mix properly but a master equalizer will not have effect on a single channel and you may overload the signal easily. Individual EQ will give you a much better control on single tracks.

7 HI

If you turn this control up, you will boost all the frequencies above 12kHz (shelving filter). You will add transparency to vocals and guitar and also make cymbals crispier. Turn the control down to cut all frequencies above 12kHz. In such way you can reduce sibilances of human voice or reduce the hiss of a Tape player.

8 MID

This is a peaking filter and it will boost/cuts frequencies with their center at 2.5kHz. This control will affect especially upper male and lower female vocal ranges and also the harmonics of most musical instruments.

9 LOW

If you turn this control up you will boost all frequencies below 80Hz. You will give more punch to bass drums and bass guitar; and you will make the male vocalist more "macho". Turn it down, and you will cut all the frequencies below 80Hz. In this way you can avoid low-frequency vibrations and resonance thus preserving the life of your woofers.

10 -20 dB PAD

Pressing this button will attenuate the input signal by 20dB. In such way you can produce increased headroom and reduce the risk of distortion because of level peaks at input level when the input signal is quite hot.



4. CONTROL ELEMENTS

MASTER SECTION

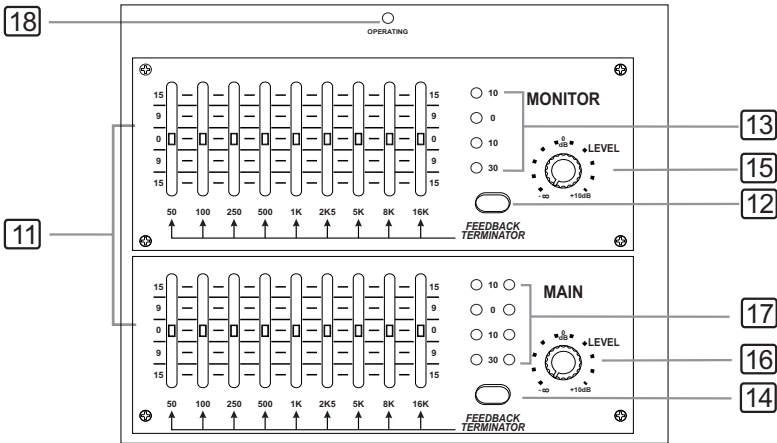

11 STEREO GRAPHIC EQ

Your PBMB is equipped with two graphic EQs with 9 adjustable bands each; one is for the MAIN MIX and the other for the MONITOR MIX. Via the faders, you can boost or cut the selected frequency by +/-15 dB at the indicated frequencies. When all faders are at the center position, the equalizer will do nothing.

12 FEEDBACK TERMINATOR Button (MONITOR MIX)

Pressing this button the feedback detection function will be activated in the monitor signal path. Feedback will be identified at a certain frequency when the correspondent fader LED lights up. Feedback will produce an unpleasant speaker "howling" or "whistling". In this case, in order to eliminate feedback, you need to turn down the corresponding fader until feedback disappears.

13 MONITOR LEVEL LED DISPLAY

This LED display will show you the monitor output level. Make sure that the +10 LED only lights up occasionally. The optimal level is when the -10 and 0 LED light up. If only the -30 LED lights up or even doesn't come to life your S/N ratio will be degraded.

14 FEEDBACK TERMINATOR Button (MAIN MIX)

By pressing this button, the feedback detection function will be activated in the Main Mix signal path. Feedback will be identified at a certain frequency when the correspondent fader LED will light up. Feedback will produce an unpleasant speaker "howling" or "whistling". In this case, in order to eliminate feedback, you need to turn down the corresponding fader until feedback disappears.

4. CONTROL ELEMENTS

15 MONITOR LEVEL CONTROL

This control is used to adjust the level of the monitor output.

16 MAIN MIX LEVEL CONTROL

This control is used to adjust the overall volume of the main mix output.

17 MAIN MIX LEVEL LED DISPLAY

This LED display will show you the Main Mix output level. Make sure that the +10 LED only lights up occasionally. The optimal level is when the -10 and 0 LED light up. If only the -30 LED lights up or even doesn't come to life your S/N ratio will be degraded.

18 OPERATING LED DISPLAY

The LED indicates when the power is switched on in your PBMB.

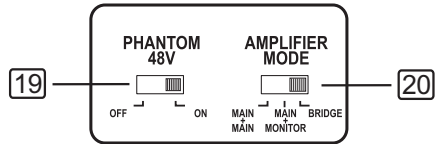

19 PHANTOM 48V SWITCH

Activating this switch, you will apply +48V phantom power only to the 8 XLR microphone inputs and only to the XLR MIC sockets. Never plug in a microphone when phantom power is already on. Before turning phantom power on, make sure that all faders are all the way down. In this way, you will protect your stage monitors and main loudspeakers.

20 AMPLIFIER MODE SWITCH

This switch provides three modes: MAIN/MAIN, MAIN/MONITOR and BRIDGE. Select any one of these modes to route the signals to the corresponding jacks according to the speaker connection at speaker jacks on the rear panel. You will find more details about the Amplifier Mode switch later on in this Manual.

MASTER SECTION INPUT AND OUTPUT JACKS

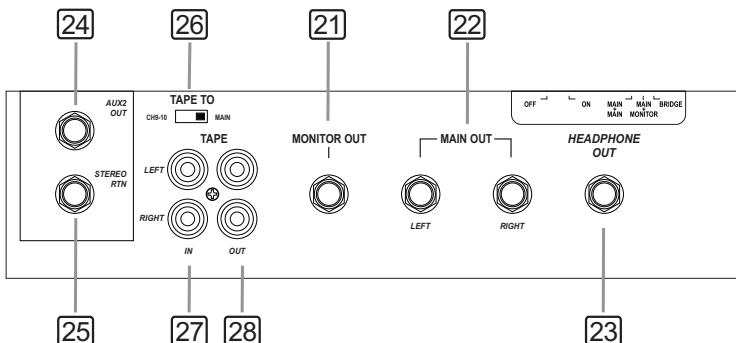



4. CONTROL ELEMENTS

21 MONITOR OUT JACK

Use this balanced MONITOR jack to connect the input of an external amplifier or active monitor speaker.

22 MAIN OUT JACKS

These jacks are used to output the Main Mix signal to an external amplifier or active speaker.

23 HEADPHONE OUT JACK

This is a stereo phone type output jack. It is used to send out the Main Mix signal to a pair of headphones.

24 AUX2 OUT JACK

The phone jack is used to output the line level signal of the AUX2 post fader bus. You can use it to feed the inputs of a stereo multi-effects (you will need a Y-type cable).

25 STEREO RETURN JACK

Use this stereo phone jack to return the stereo signal of an effect unit into the Main Mix. You can also use it as the extra auxiliary input.

26 TAPE TO SELECT SWITCH

If you position this switch to the left, you will route the signal fed into the TAPE IN sockets into CH9~10 path, and the signal will be affected by channel level control, channel EQ, DSP send, and MAIN level control, while positioning this switch to the right will route the TAPE IN signal into Main Mix bus. In this case, signal will be affected only by Main level control.

27 TAPE IN CONNECTORS

Your PBMB features dual RCA jacks for TAPE IN (left and right). Typically, these connectors are used to feed into the mixer the stereo signal from a CD Player, Tape or DAT Player, iPod, MP3 and so on. It is useful to use these inputs this way if you stop the GIG for a couple of beers or more.

28 TAPE OUT

Your PBMB also includes dual RCA jacks for stereo out (left and right). Via these jacks, you can route the Main Mix signal into a tape recorder or DAT for recording your session.



4. CONTROL ELEMENTS

DSP SECTION

There is a powerful 24-bit/256 preset digital multi-effects included in your PBM8. Effects include reverbs, chorus, flanger, delay and combinations of the above.

29 PRESETS Control

This knob will select one of the 16 Factory Presets.

30 DSP MUTE Button

This button is used to activate/deactivate the digital multi-effect. Alternatively, you can also use the DSP FOOTSWITCH for a faster operation.

31 PEAK LED

This LED will flash when the signal input into the digital multi-effect is too strong. When the digital effect module is muted by the (30) button the LED also lights up.

32 VARIATIONS Control

For each of the 16 Factory Presets you can apply up to 16 variations, so in total your PBM8 offers 256 different presets. If you want to know which Parameter is modified by this control, please look at the following chart.

33 DSP TO MON

This control is used to control the volume of the processed signal sent to Monitor Mix, which can be varied from $-\infty$ to +10 dB.

34 DSP TO MAIN

This control is used to control the volume of the processed signal sent to Main Mix bus, which can be varied from $-\infty$ to +10 dB.

35 DSP FOOTSWITCH Socket

This 1/4" phone jack can be used to connect an external optional footswitch to turn on/off the onboard digital multi-effect.

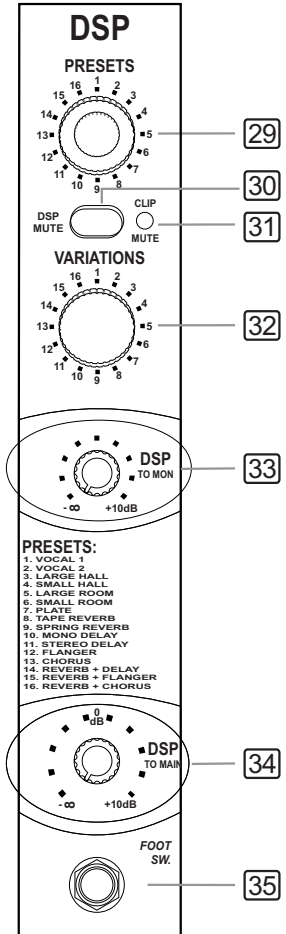



4. CONTROL ELEMENTS

REAR PANEL

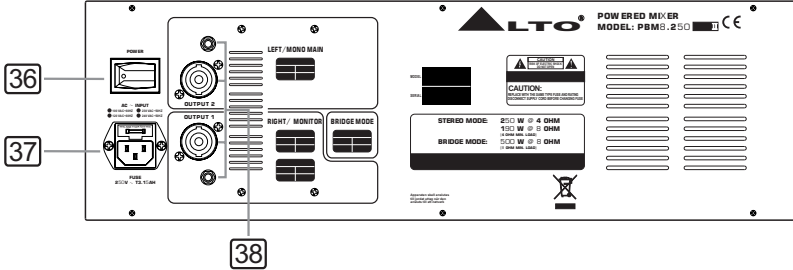

36 POWER ON/OFF Switch

This switch is used to turn the main power ON and OFF.

37 AC Inlet with FUSE Holder

Use it to connect your PBMB to the main AC with the supplied AC cord. Please check the voltage available in your country and how the voltage for your PBMB is configured before attempting to connect your PBMB to the main AC.

38 SPEAKERS Jacks

These jacks are used to connect speakers. They are configured with 4-way speakon connectors and 1/4" phone jacks. You can determine the signal that is output to these jacks according to the setting of the AMPLIFIER MODE select switch, as we will describe in a moment.

Note: In order to avoid damage to the built-in amplifier, please pay attention to the allowed impedance of the speaker. Very low load impedances may damage the amplifier. Look at this plate on your PBMB for reference.

STEREO MODE:	250 W @ 4 OHM
	190 W @ 8 OHM
	(4 OHM MIN. LOAD)
BRIDGE MODE:	500 W @ 8 OHM
	(8 OHM MIN. LOAD)
▲ CLASS 2 WIRING MAY BE USED ▲	

PBMB.250 MKII

STEREO MODE:	500 W @ 4 OHM
	300 W @ 8 OHM
	(4 OHM MIN. LOAD)
BRIDGE MODE:	1000 W @ 8 OHM
	(8 OHM MIN. LOAD)
▲ CLASS 2 WIRING MAY BE USED ▲	

PBMB.500 MKII



5. INSTALLATION AND CONNECTION

Ok, you have got to this point and you are now in the position to successfully operate your PBM8. However, we advise you to read carefully the following section to be the real master of your own mix. Not paying attention enough to the input signal level, to the routing of the signal and the assignment of the signal will result in unwanted distortion, a corrupted signal or no sound at all. So you should follow this procedure for every single channel:

1. Turn down all Input and output gain controls.
2. Connect phantom powered microphones before switching on the +48 V phantom power switch.
3. Set the output level of your PBM8 or the connected power amplifier at no more than 75%.
4. Now, set the MONITOR level at no more than 50%. In this way you will be able to hear later what you are doing connecting a pair of headphones or a pair of powered studio monitor speakers.
5. Position EQ controls on middle position.
6. Position panoramic (PAN) control on center position.
7. Increase the input gain properly for maintaining the good headroom and ideal dynamic range.
8. Depending on the actual application, turn slowly the input and output level controls for obtaining the maximum gain before distortion.
9. Now repeat the same sequence for all input channels. The main LED meter could move up into the red section. In this case you can adjust the overall output level through the MAIN MIX control.

Audio Connections

You can connect unbalanced equipment to balanced inputs and outputs. Simply follow these schematics.

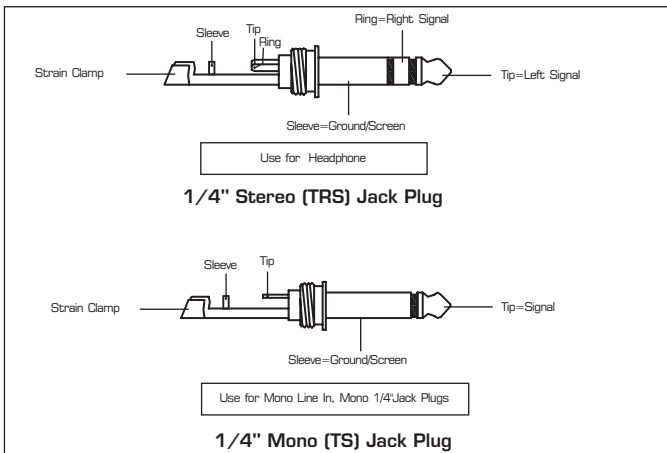



5. INSTALLATION AND CONNECTION

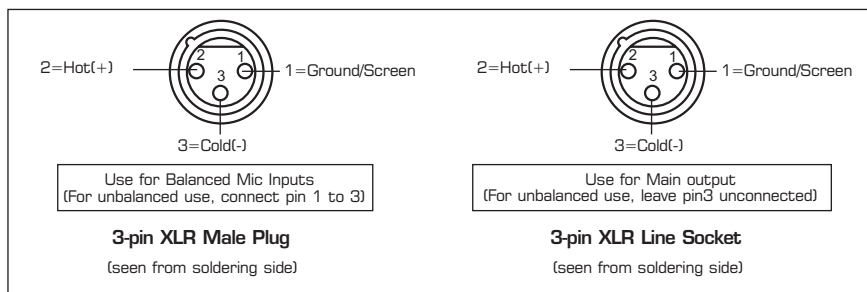
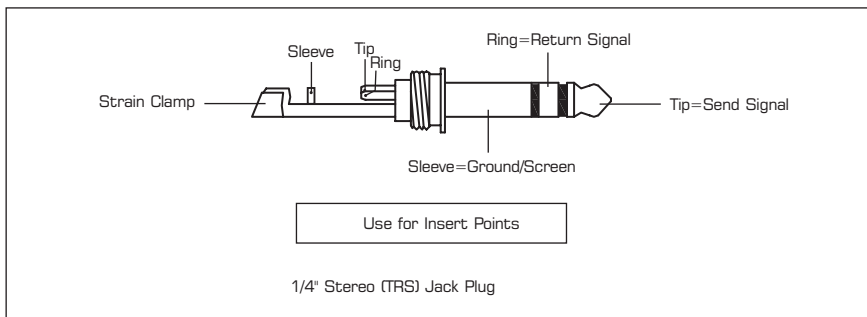

MAIN SPEAKERS CONNECTION

Please use only the power connectors to make connections with other signal source equipment for the passive speaker cabinets. The power connector has four terminals: 1+, 1-, 2+, 2-.

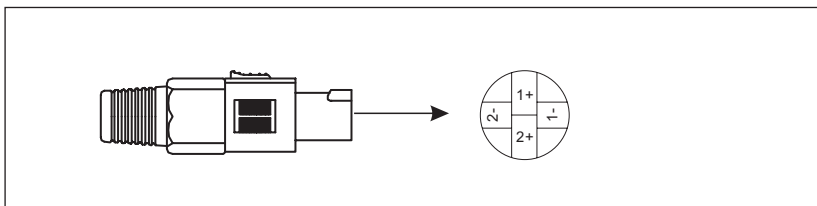

Speakon connector



5. INSTALLATION AND CONNECTION

And now some tips how to use the **AMPLIFIER MODE** switch

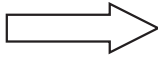
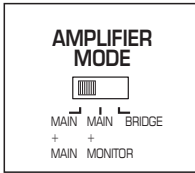

Main Speaker

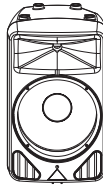
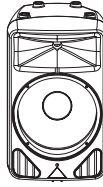

Main Speaker

MAIN + MAIN Mode

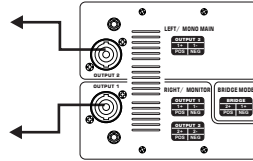

Use either the speaker jacks or phone jacks

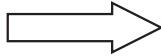
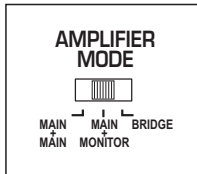

Main Speaker

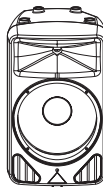

Monitor Speaker

MAIN + MONITOR Mode

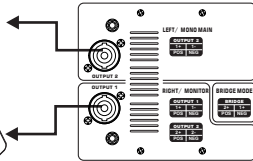

Use either the speaker jacks or phone jacks

With the **AMPLIFIER MODE** in **MAIN+MONITOR** position, channel1 drives a Main speaker cabinet while channel2 drives a stage monitor.



5. INSTALLATION AND CONNECTION

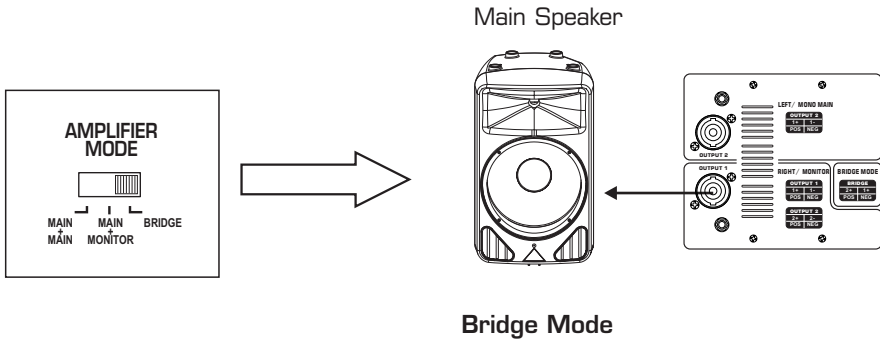

With the AMPLIFIER MODE switch in BRIDGE position, the two power amplifiers in your PBM8 drive together a single speaker cabinet with the sum of the power of the 2 amps. Usually this solution is used to drive a single subwoofer and the MAIN OUT output on the front panel are used to feed a pair of powered speakers as mid-high units.

6. PRESET LIST

NO.	Preset	Description	Controllable Parameter	
			Parameter	Variable range
1	VOCAL1	Simulate a room with small delay time.	Decay time Pre-delay	0.8~1.1s 0~79ms
2	VOCAL2	Simulate a small space with slight decay time	Decay time Pre-delay	0.8~2.5s 0~79ms
3	LARGE HALL	Simulate a large acoustic space of the sound.	Decay time Pre-delay	3.6~5.4s 23~55ms
4	SMALL HALL	Simulate a stage space of the sound.	Decay time Pre-delay	1.0~2.9s 20~45ms
5	LARGE ROOM	Simulate a studio room with many early reflections	Decay time Pre-delay	2.9~4.5s 23~55ms
6	SMALL ROOM	Simulate a bright studio room.	Decay time Pre-delay	0.7~2.1s 20~45ms
7	PLATE	Simulate the transducers sound like classic bright vocal plate.	Decay time Pre-delay	0.6~6.1s 10ms
8	TAPE REVERB	Simulate a record head and multiple playback heads at intervals along the tape.	Decay time Pre-delay	1.3~5.4s 0~84ms
9	SPRING REVERB	Simulate the analog transducers' springs lightly stretched sound.	Decay time Pre-delay	1.3~5.4s 0~35ms
10	MONO DELAY	Reproduce the sound input on the output after a lapse of time.	Period	60~650ms
11	STEREO DELAY	Recreate the input sound on the stereo output with different time.	Period Feedback	210~400ms 37~73%
12	FLANGER	Simulate to play with another person carrying out same the notes on the same instrument	Rate	0.16~2.79Hz
13	CHORUS	Recreate the illusion of more than one instrument from a single instrument sound	Rate	0.5~5Hz
14	REV.+DELAY	Delay with room effect	Decay period Rev.decay time	211~375ms 1.0~2.9s
15	REV.+FLANGER	Stereo chorus and large room reverb	Flanger Rate Rev.decay time	0.16~2.52Hz
16	REV.+CHORUS	Stereo flanger and large room reverb	Chorus rate Rev.decay time	0.5~4.74Hz 1.5~2.9s

7. BLOCK DIAGRAM

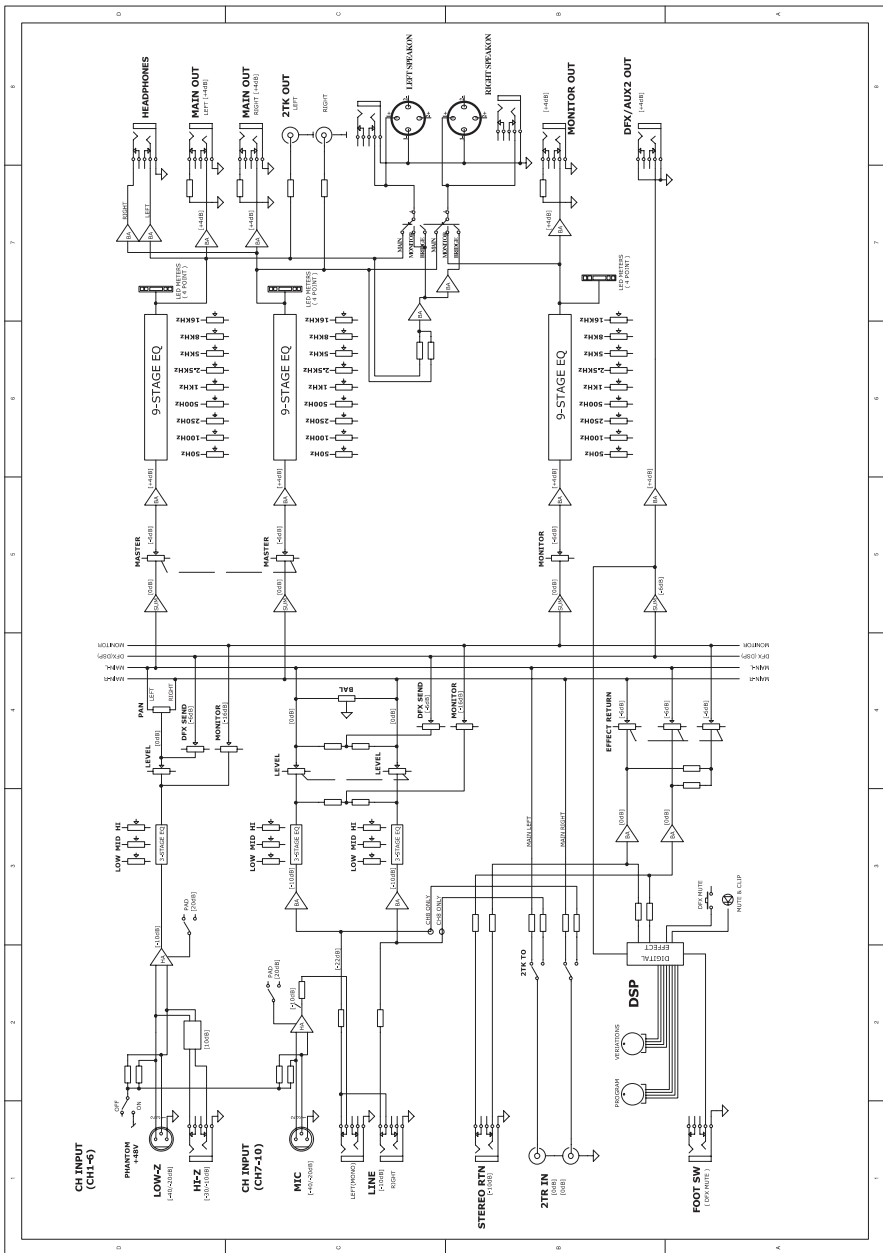

8. TECHNICAL SPECIFICATION

Mono input channels

Microphone input	Electronically balanced, discrete input configuration
Frequency response	10 Hz to 55 kHz, +/- 3 dB
Distortion (THD & N)	0.006% at +4 dBu, 1 kHz
Gain	50 dB (MIC)
SNR (Signal to Noise Ratio)	>90 dB
Line input	Electronically balanced
Frequency response	10 Hz to 55 kHz, +/- 3 dB
Distortion (THD & N)	0.04% at +4 dBu, 1 kHz
Gain	30 dB

Stereo input channels

Line input	Unbalanced
Frequency response	10 Hz to 55 kHz, +/- 3 dB
Distortion (THD & N)	0.006% at +4 dBu, 1 kHz

Impedances

Microphone input	1.4 kOhm
Channel Insert return	2.5 kOhm
All other inputs	10 kOhm or greater
Tape out	1 kOhm
All other output	120 Ohm

Equalization

Hi shelving	+/- 15 dB @12 kHz
Mid bell	+/- 15 dB @ 2.5 kHz
Low shelving	+/- 15 dB @ 80 Hz

DSP Section

A/D and D/A converters	24 bit
DSP resolution	24 bit
Type of effects	Hall, Room, Vocal & Plate REVERBS Mono & Stereo DELAY (max DELAY TIME 650ms) Chorus, Flanger & Reverb MODULATIONS REVERB+DELAY, REVERB+CHORUS, REVERB+FLANGER combinations
Presets	256
Controls	16-position PRESET Selector 16-position VARIATION selector CLIP LED MUTE SWITCH with LED indicator

Main Mix Section

Noise (bus noise)	Fader 0dB, all input channels assigned and set to UNITY gain: - 71 dB _r (ref.: +4 dBu)
Max output	+27 dBu balanced , +22 dBu unbalanced, 1/4" jacks
AUX Sends max out	+22 dBu

Power supply

Main voltage	100 VAC ~ 60 Hz	230 VAC ~ 50 Hz
	120 VAC ~ 60 Hz	240 VAC ~ 50 Hz

Power Consumption

PBM8.250 MKII

Stereo mode: 250 W @ 4 ohm(EIAJ)	222 W @ 4 ohm(RMS) THD= 1%
190 W @ 8 ohm(EIAJ)	149 W @ 8 ohm(RMS) THD= 1%
Bridge mode: 500 W @ 8 ohm(EIAJ)	415 W @ 8 ohm(RMS) THD= 1%

PBM8.500 MKII

Stereo mode: 500 W @ 4 ohm(EIAJ)	400 W @ 4 ohm(RMS) THD= 1%
300 W @ 8 ohm(EIAJ)	263 W @ 8 ohm(RMS) THD= 1%
Bridge mode: 1000 W @ 8 ohm(EIAJ)	738 W @ 8 ohm(RMS) THD= 1%

8. TECHNICAL SPECIFICATION

Fuse	PBM8.250 MKII	100 ~ 120V : T6.3AL 210 ~ 240V : T3.15AL
	PBM8.500 MKII	100 ~ 120V : T10AL 210 ~ 240V : T6.3AL
Physical		
Dimension (WxDxH)	550 x 220 x 310 mm (8.66"x12.20"x2.65")	
Weight	PBM8.250 MKII	(Net) : 13.2kg (28.70lb) (Gross) : 15.93kg (35.11lb)
	PBM8.500 MKII	(Net) : 13.5kg (29.76lb) (Gross) : 16.26kg (35.84lb)

9. WARRANTY

1. WARRANTY REGISTRATION CARD

To obtain Warranty Service, the buyer should first fill out and return the enclosed Warranty Registration Card within 10 days of the Purchase Date.

All the information presented in this Warranty Registration Card gives the manufacturer a better understanding of the sales status, so as to provide a more effective and efficient after-sales warranty service. Please fill out all the information carefully and genuinely, miswriting or absence of this card will void your warranty service.

2. RETURN NOTICE

- 2.1 In case of return for any warranty service, please make sure that the product is well packed in its original shipping carton, and it can protect your unit from any other extra damage.
- 2.2 Please provide a copy of your sales receipt or other proof of purchase with the returned machine, and give detail information about your return address and contact telephone number.
- 2.3 A brief description of the defect will be appreciated.
- 2.4 Please prepay all the costs involved in the return shipping, handling and insurance.

3. TERMS AND CONDITIONS

- 3.1 ▲LTO warrants that this product will be free from any defects in materials and/or workmanship for a period of 1 year from the purchase date if you have completed the Warranty Registration Card in time.
- 3.2 The warranty service is only available to the original consumer, who purchased this product directly from the retail dealer, and it can not be transferred.
- 3.3 During the warranty service, ▲LTO may repair or replace this product at its own option at no charge to you for parts or for labor in accordance with the right side of this limited warranty.
- 3.4 This warranty does not apply to the damages to this product that occurred as the following conditions:
 - Instead of operating in accordance with the user's manual thoroughly, any abuse or misuse of this product.
 - Normal tear and wear.
 - The product has been altered or modified in any way.
 - Damage which may have been caused either directly or indirectly by another product / force / etc.
 - Abnormal service or repairing by anyone other than the qualified personnel or technician.

And in such cases, all the expenses will be charged to the buyer.

- 3.5 In no event shall ▲LTO be liable for any incidental or consequential damages. Some states do not allow the exclusion or limitation of incidental or consequential damages, so the above exclusion or limitation may not apply to you.
- 3.6 This warranty gives you the specific rights, and these rights are compatible with the state laws, you may also have other statutory rights that may vary from state to state.

SEIKAKU TECHNICAL GROUP LIMITED
NO. 1, Lane 17, Sec. 2, Han Shi West Road, Taichung 40151, Taiwan
<http://www.altoproaudio.com> Tel: 886-4-22313737
email: alto@altoproaudio.com Fax: 886-4-22346757

All rights reserved to ALTO. All features and content might be changed without prior notice. Any photocopy, translation, or reproduction of part of this manual without written permission is forbidden. Copyright ©2007 Seikaku Group